

5~17V转3.8V, 3.8V转3.3V电路

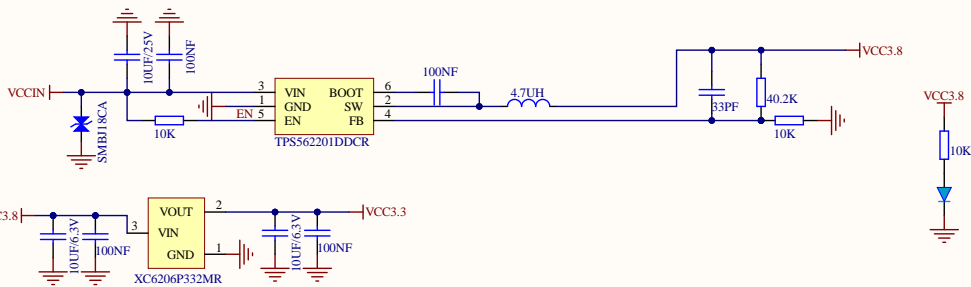

GM190模块

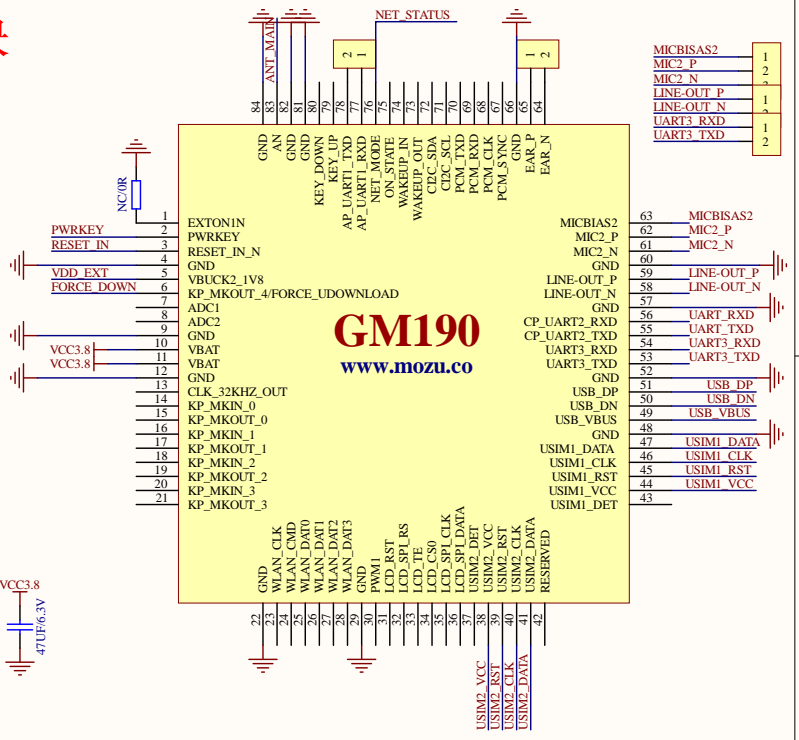
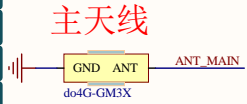

接口电路

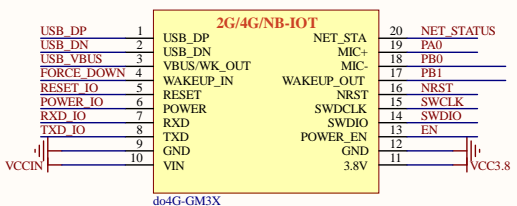

UART电平转换电路

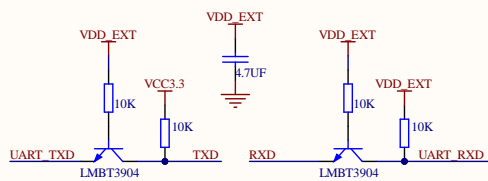

定位孔

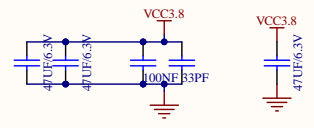

复位电路

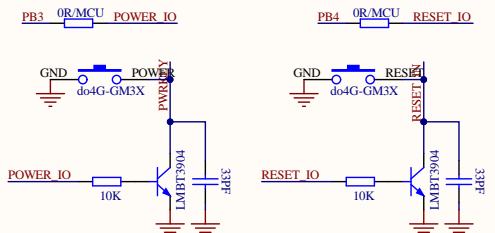

注：复位至少拉低1秒

注：开机0.2秒，关机3秒

NanoSIM卡1电路

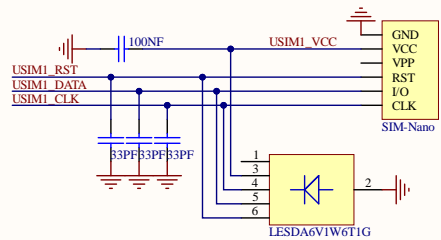

串口选择

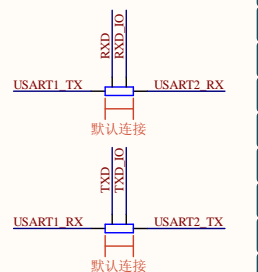

MCU

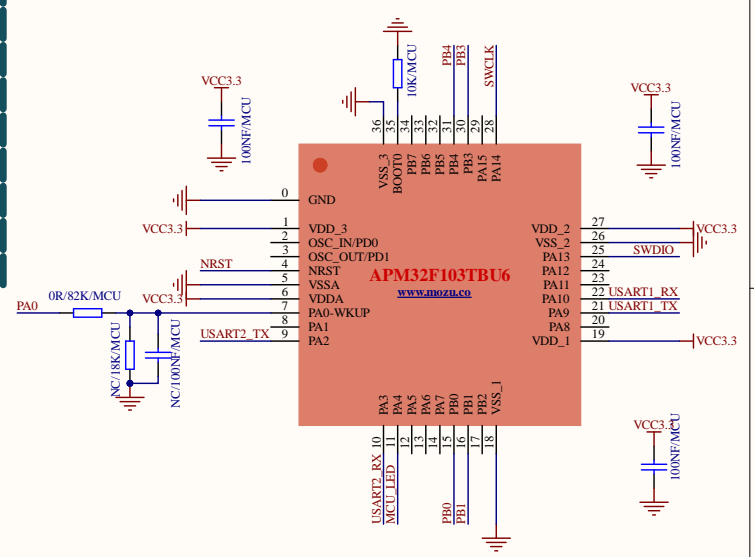

状态指示灯

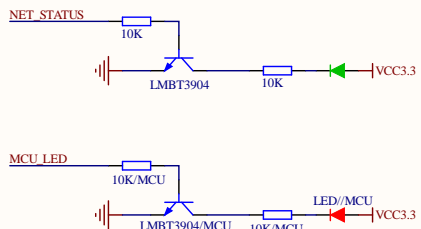

NanoSIM卡2电路

